

MANUAL

MH-200 HYBRID PRO MKII

HIGHLY
EFFICIENT LED 

DOUBLE
PRISM 

IRIS &
FROST 

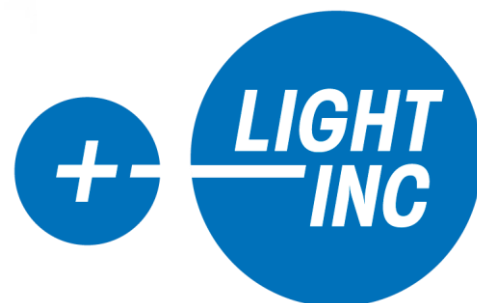















WWW.LIGHT-INC.NL

THANK YOU FOR PURCHASING OUR PRODUCTS.

Every unit has been thoroughly tested and has been shipped in perfect operating condition. Carefully check the outer and inner packaging for damage that may have occurred during shipping. If the carton appears to be damaged, carefully inspect your fixture for any damage and be sure all accessories necessary to operate the unit have arrived intact. In case damage has been found or parts are missing, please contact the distributor or your dealer for further instructions. Do not return this unit to your dealer without first contacting them.

1. SAFETY INFORMATION

	Before operating this unit, please carefully read this manual and keep for usage in the future. It is necessary to respect the following rules.
	Disposal of the device after its life cycle can damage the environment. Take it to a recycling company or return it to the authorized dealer.
	The products referred to in this manual conform to the guidelines of the European Community and are therefore marked with the CE logo.
	Keep this device away from children and unauthorized users. The dealer is not liable for damage as a result of ignoring the information in this manual and incorrect operation.
	Before operating this unit, please make sure the housing is in good condition and ensure pan and tilt can rotate in full range.
	Ensure that a minimum distance of 0.5 m is maintained between the fixture and any flammable material.
	The device can only function with 100-240v voltage, 50 / 60Hz power. Do not connect to any other power supply. Disconnect the device from the power supply before opening it or before maintenance.
	Never look directly into the projecting lens when the fixture is switched on. The light can cause epileptic seizures in light-sensitive people or people with epilepsy. Extreme caution and compliance with these safety instructions are required, especially with beam effects.
	Do not place or install the device on a surface that is exposed to vibration or any movement.
-15°C + 45°C	The device should operate in temperature range -15 °C and + 45 °C. Do not use the device if the temperature exceeds this range.
	The lens shield must be replaced if it is broken. Never use the device if the shield is not fully closed.
	Safety I class device must be earthed.
	When the fixture is mounted overhead, the safety rope must be attached to the correct mounting location on the bottom of the device.
	Please note that damage caused by manual changes to the device is not covered by the warranty.
	If possible, recycle all packaging material

2. SETTING UP:

Power Supply: Before plugging in your unit, be sure the voltage in your area matches the required voltage for your fixture. The unit has auto power supply and is workable in 90-250V/50-60Hz.

Connection to the mains: For protection from electric shock, the fixture **must** be earthed. Install a suitable plug on the power cord, note that the cores in the power cord are colored according to the following table. The earth has to be connected!
If you have any doubts about proper installation, consult a qualified electrician.

Core (EU)	Core (US)	Connection	Plug Terminal Marking
Brown Light blue Yellow/Green	Black White Green	Live Neutral Earth	L N 

DMX512 connection:

The fixture is equipped with 3-pin and 5-pin XLR sockets for DMX input and output. The sockets are wired in parallel.

Only use a shielded twisted-pair cable designed for RS-485 and 3-pin or 5-pin XLR-plugs and connectors in order to connect the controller with the fixture or one fixture with another.

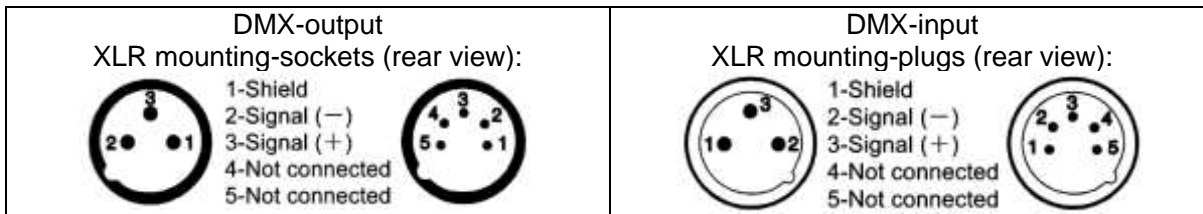

DMX Linking: To ensure proper DMX data transmission when using several DMX fixtures, try to use the shortest cable path possible. The order in which fixtures are connected in a DMX line does not influence the DMX addressing. For example; a fixture assigned a DMX address of 1 may be placed anywhere in a DMX line. When a fixture is assigned a DMX address of 1, the DMX controller knows to send DATA assigned to address 1 to that unit, no matter where it is located in the DMX chain.

Operating Modes: You can use the fixture in 3 ways:

- Auto Mode - The unit will automatically chase through the different colors and built-in programs.
- Slave Mode – The unit will run under slave mode.
- DMX control mode - This function will allow you to control each individual fixture’s traits with a standard DMX 512 controller.

DMX Mode: Operating through a DMX controller gives the user the freedom to create their own programs tailored to their own individual needs. This function also allows you to use your fixtures as spotlights.

- This function will allow you to control each individual fixture’s traits with a standard DMX 512 controller.
- The fixture uses 16/19 two DMX channels modes to operate. Please see “DMX Values and Functions” for the DMX traits.
- To run your fixture in DMX mode, plug in the fixture via the XLR connections to any standard DMX controller. Set your desired DMX address following the setup specifications that comes with your DMX controller.

Touch Buttons:

There are four touch buttons under the LCD display: Menu, Up, Down, Enter. Normally, the LED will display the current DMX address code of the fixture. At this time, press up and down to choose the function you want.



LED Operation Menu: LED screen with four touch buttons: **MENU, UP, DOWN and ENTER.**

LCD display operation:

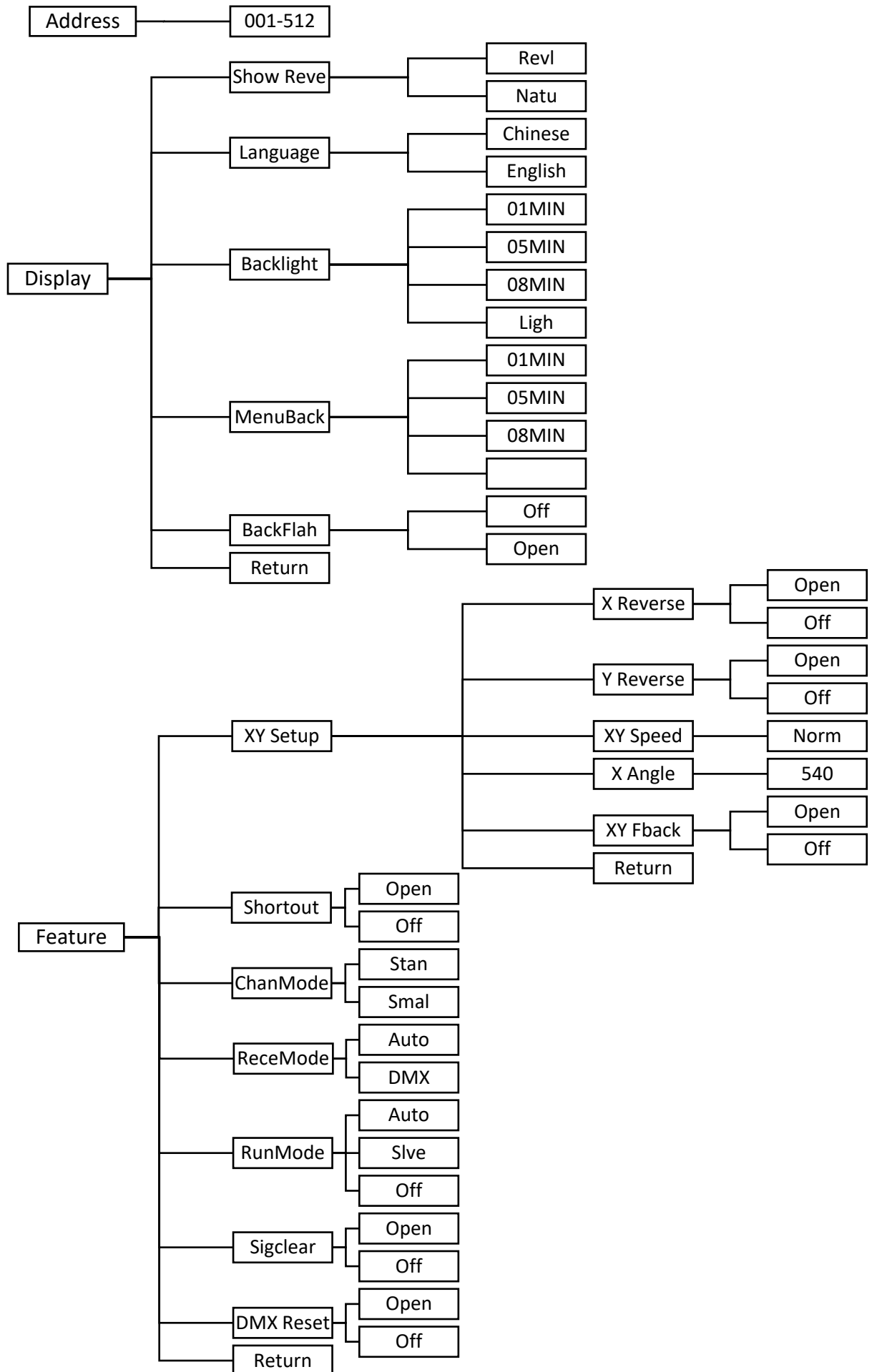

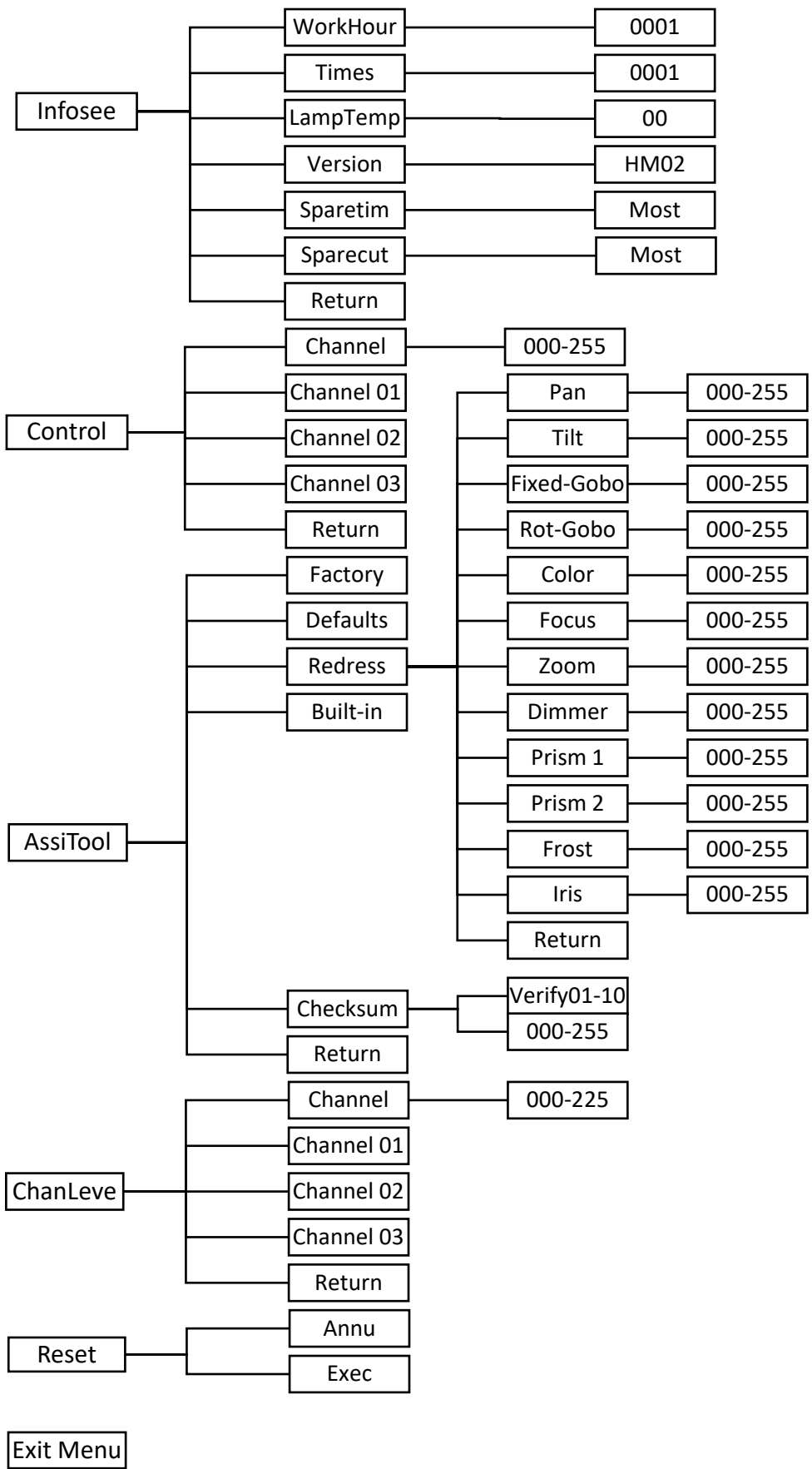

3. DMX CHART:

Standard Mode	Reduced Mode	DMX Value	Function
1	1	0~255	Pan 0~540
2	*	0~255	Pan Fine 16bit
3	2	0~255	Tilt 0~230
4	*	0~255	Tilt Fine 16bit
5	*	0~255	Pan/Tilt Speed Fast-Slow
6	3	0~255	Dimmer
7	4	Strobe	
		0-2	Open
		3~103	Strobe slow-fast
		104~107	Open
		108~207	Pulse Strobe 1 Slow to Fast
		208~212	Open
		213~238	Pulse Strobe 2 Slow to Fast
		239~251	Random Strobe 2 Slow to Fast
252~255	Open		
8	5	Color Wheel	
		0~128	Index
		129~131	Red
		132~135	Yellow
		136~138	Blue
		139~142	Magenta
		143~146	Cyan
		147~150	Pink
		151~154	Green
		155~158	Orange
		159~207	Forward Fast-Slow
208~255	Backward Slow-Fast		
9	6	Static Gobo Wheel	
		0~7	Open
		8~15	Gobo 1
		16~23	Gobo 2
		24~31	Gobo 3
		32~39	Gobo 4
		40~47	Gobo 5
		48~55	Gobo 6
		56~63	Gobo 7
		64~70	Gobo 7 shake Fast - slow
		71~77	Gobo 6 shake Fast - slow
		78~84	Gobo 5 shake Fast - slow
		85~91	Gobo 4 shake Fast - slow
		92~99	Gobo 3 shake Fast - slow
		100~107	Gobo 2 shake Fast - slow
		108~114	Gobo 1 shake Fast - slow
		115~185	Forward Fast-Slow
		186~255	Backward Slow-Fast

10	7	Rotation Gobo Wheel	
		0~7	Open
		8~15	Gobo 1
		16~23	Gobo 2
		24~31	Gobo 3
		32~39	Gobo 4
		40~47	Gobo 5
		48~55	Gobo 6
		56~63	Gobo 7
		64~70	Gobo 7 shake Fast - slow
		71~77	Gobo 6 shake Fast - slow
		78~84	Gobo 5 shake Fast - slow
		85~91	Gobo 4 shake Fast - slow
		92~99	Gobo 3 shake Fast - slow
		100~107	Gobo 2 shake Fast - slow
		108~114	Gobo 1 shake Fast - slow
		115~185	Forward Fast-Slow
186~255	Backward Slow-Fast		
11	8	Gobo Rotation	
		0~127	Gobo index
		128~187	Gobo Forward Rotation(Fast-Slow)
		188~194	Stop
		195~255	Gobo Backward Rotation(Slow-Fast)
12	9	0~128	Iris Index
		129~255	Iris Pulse
13	10	0~127	NO
		128~255	Frost
14	11	Prism	
		0~10	Open
		11~128	Prism 1 8 faced
		129~255	Prism 2 6 linear
15	12	Prism1 Rotation	
		0~128	Prism 1 index
		129~187	Prism 1 Backward Rotation Fast-Slow
		188~255	Prism 1 Forward Rotation Slow-Fast
16	13	Prism2 Rotation	
		0~128	Prism 2 index
		129~187	Prism 2 Backward Rotation Slow-Fast
		188~255	Prism 2 Forward Rotation Slow-Fast
17	14	0~255	Zoom
18	15	0~255	Focus
19	16	0~127	NO
		128~255	All-Reset

*BASED ON VERSION HM02

4. RIGGING THE FIXTURE

Caution:

- Fixture may cause severe damage when falling down. If you have doubts concerning the safety of a possible installation, do not install the moving head.
- Before rigging make sure that the installation area can hold a minimum point load of 10 times the fixtures weight.
- When installing the device, make sure there is no highly inflammable material (decoration material etc.) in a distance of 1.0 m.
- Use an appropriate clamp to rig the fixture on the truss.
- Follow the instructions mentioned at the bottom of the base.
- Make sure that the device is fixed properly. Ensure that the structure (truss) to which you are attaching the fixtures is secure.

Securing the fixture via one safety wire Securing the fixture via two safety wires

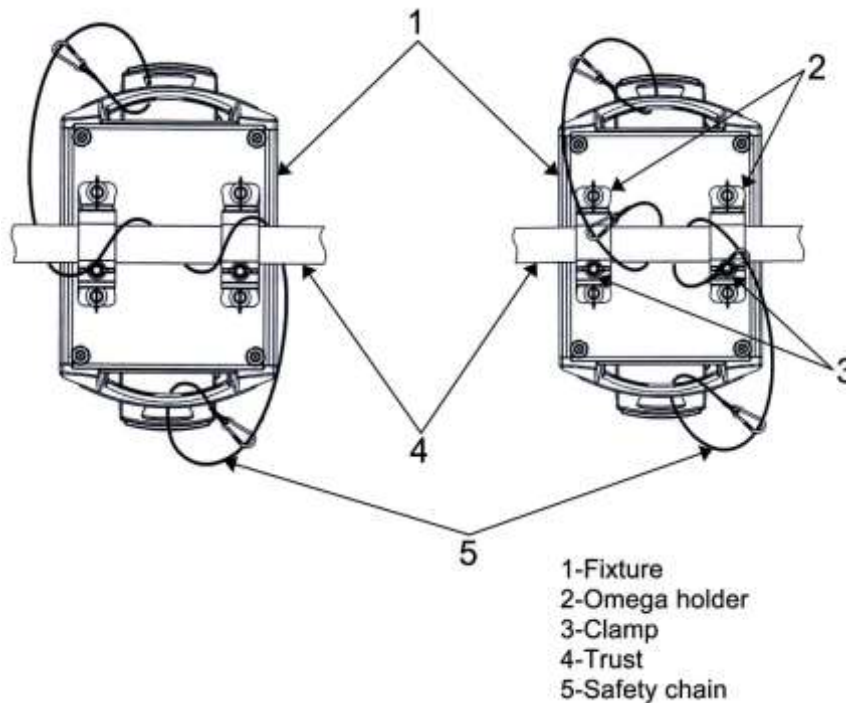

5. FEATURES

- Multi-Colors + gobo's
- Color strobe
- Electronic Dimming 0-100%
- DMX-512 protocol
- Master/Slave synchronization
- LCD operation menu with function buttons
- Daisy Chain units together in DMX Mode

6. TECHNICAL SPECIFICATIONS

Electrical

- Power supply: Electronic auto-ranging
- Input voltage range: 90-250V, 50/60Hz
- Fuse: 5 A@220V
- Power consumption: 300W@230V

Optic

- Light source: LumiEngine 1piece *200W White LED
- LED lifespan: 6,0000 hours
- Dimmer: Smooth dimmer from 0-100%
- Fixed gobo wheel: 7 gobos + open
- Rotating gobo wheel: 7 gobos + open
- Color wheel: 8 colors + open
- 6 linear + 8-facet dual prisms
- Focus, Frost & Iris

Motorized

- Pan/Tilt
- Pan movement range: 540°
- Tilt movement range: 270°
- 16 bit movement resolution
- Automatic Pan/Tilt position correction
- Pan movement 0°-540°at max Speed: 2.2 sec.
- Tilt movement 0°-270°at max Speed: 1.2 sec.

LCD operation

- Built-in demo sequences
- Silent cooling fans
- Strong three-phase motors
- Stand-alone operation
- Supported protocols: DMX512
- 2 DMX modes (19/16 control channels)

Connection

- DMX data in/out: Locking 3-pin and 5-pin XLR
- AC power input: 1.5m power cord with plug

Rigging

- Mounting points: 2 pairs of 1/4-turn locks
- Mounting horizontally or vertically via 2 Omega brackets

Temperatures

- Maximum ambient temperature: 45°C
- Maximum housing temperature: 75°C
- Total heat dissipation: 1200 BTU/h (calculated)

Dimensions

- Net dimensions: 380(L) x 247(W) x 550(H) mm
- Weight (net): 22kg

